

DIN 97, Senkholzschraube, HO 4x70, A2

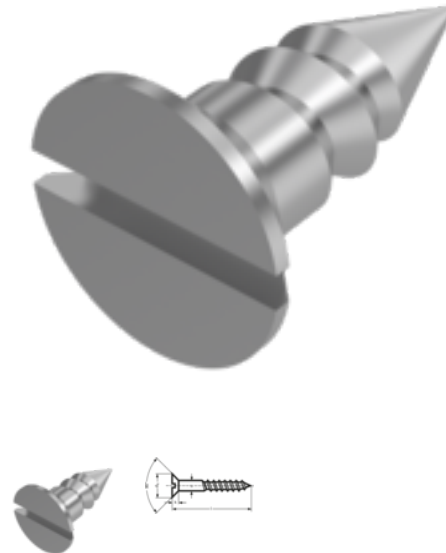

Artikel-Nr.
520097470

EAN
None

Gewicht in kg
0,005

Zolltarifnummer
73181210

Material
Edelstahl

Güte
A2

Beschichtung
blank

Durchmesser
4 mm

Länge
70 mm

Produktdetails

Material	Edelstahl
Kraftangriff Typ	Schlitz
Länge	70 mm
Gesamtlänge l	70 mm
Norm	DIN 97
Durchmesser	4 mm
Güte	A2
Kopfhöhe k	2.2 mm
Kraftangriff s	SZ 1
Beschichtung	blank
Kopfdurchmesser dk	7.5 mm
Durchmesser d	4 mm

Artikelvarianten

Durchmesser (mm)	2,5	3	3,5	4	4,5	5	5,5	6	8	10
Länge (mm)										
10	•	•		•						
12	•	•	•							
16	•	•	•	•	•	•				
20	•	•	•	•	•	•				
25	•	•	•	•	•	•	•	•		
30		•	•	•	•	•	•	•	•	
35			•		•	•	•	•		
40		•	•	•	•	•	•	•	•	
45				•	•	•	•	•		
50			•	•	•	•	•	•	•	
60				•	•	•	•	•		
65						•		•		
70				•		•	•	•	•	
75						•	•			
80						•		•	•	
90						•	•		•	
100						•	•	•	•	
110								•		
120								•	•	•