

# DIN 97, Senkholzschraube, HO 5x40, A2

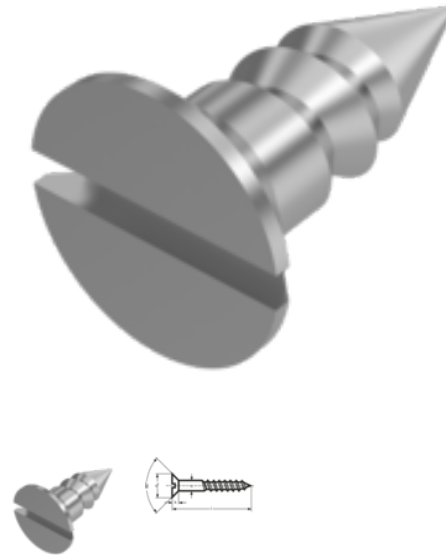

**Artikel-Nr.**  
520097540

**EAN**  
None

**Gewicht in kg**  
0,005

**Zolltarifnummer**  
73181210

**Material**  
Edelstahl

**Güte**  
A2

**Beschichtung**  
blank

**Durchmesser**  
5 mm

**Länge**  
40 mm

## Produktdetails

Material	Edelstahl
Kraftangriff Typ	Schlitz
Länge	40 mm
Gesamtlänge l	40 mm
Norm	DIN 97
Durchmesser	5 mm
Güte	A2
Kopfhöhe k	2.5 mm
Kraftangriff s	SZ 1,2
Beschichtung	blank
Kopfdurchmesser dk	9.2 mm
Durchmesser d	5 mm

## Artikelvarianten

Durchmesser (mm)	2,5	3	3,5	4	4,5	5	5,5	6	8	10
Länge (mm)										
10	•	•		•						
12	•	•	•							
16	•	•	•	•	•	•				
20	•	•	•	•	•	•				
25	•	•	•	•	•	•	•	•		
30		•	•	•	•	•	•	•	•	
35			•		•	•	•	•		
40		•	•	•	•	•	•	•	•	
45				•	•	•	•	•		
50			•	•	•	•	•	•	•	
60				•	•	•	•	•		
65						•		•		
70				•		•	•	•	•	
75						•	•			
80						•		•	•	
90						•	•		•	
100						•	•	•	•	
110								•		
120								•	•	•